

PREISLISTE

NETTO-PREISLISTE FÜR HANDELSPARTNER

**EG** VERANDA



PREISLISTE 2025

**EG** ALUMINIUM

# PRIME PLUS + R-LINE OHNE GLAS

**Bis zu 5m. Nur 2 Pfosten!**

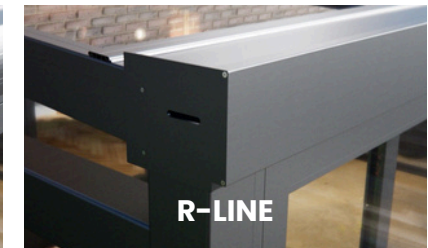

OHNE GLAS	300 CM	400 CM	506 CM	606 CM	706 CM	806 CM	906 CM	1006 CM	1106 CM	1206 CM
200 CM	798€	962€	1.051€	1.140€	1.282€	1.371€	1.622€	1.765€	1.983€	2.193€
250 CM	954€	1.000€	1.105€	1.193€	1.307€	1.403€	1.677€	1.788€	2.060€	2.202€
300 CM	1.042€	1.126€	1.230€	1.252€	1.394€	1.504€	1.774€	1.890€	2.007€	2.123€
350 CM	1.315€	1.437€	1.550€	1.689€	1.784€	1.924€	2.243€	2.471€	2.626€	2.736€
400 CM	1.478€	1.622€	1.652€	1.924€	2.008€	2.100€	2.529€	2.798€	2.950€	3.184€
450 CM	1.655€	1.832€	2.040€	2.396€	2.859€	3.227€	3.848€	4.047€	4.323€	4.400€

## OPTION

Gerade Dachrinnenleiste  
€ 15,- per meter

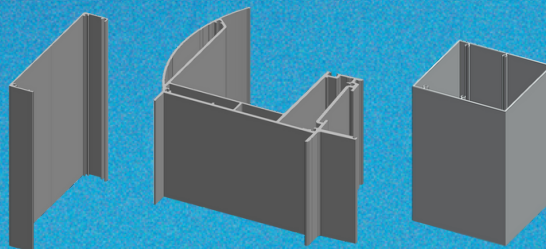

## STANDARDFARBEN

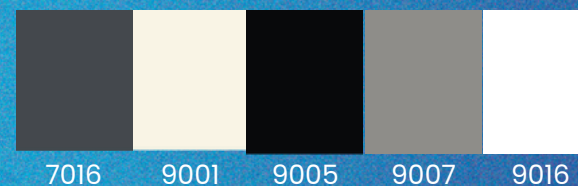

# PRIME PLUS + R-LINE POLYCARBONAT

**Bis zu 6m. nur 2 Pfosten!**



POLY	300 CM	400 CM	506 CM	606 CM	706 CM	806 CM	906 CM	1006 CM	1106 CM	1206 CM
200 CM	734€	849€	997€	1.112€	1.235€	1.409€	1.515€	1.778€	1.838€	2.029€
250 CM	815€	971€	1.120€	1.261€	1.409€	1.621€	1.749€	2.020€	2.092€	2.266€
300 CM	921€	1.095€	1.235€	1.350€	1.498€	1.723€	1.846€	2.143€	2.240€	2.397€
350 CM	1.027€	1.192€	1.341€	1.515€	1.655€	1.995€	2.160€	2.555€	2.729€	2.886€
400 CM	1.087€	1.311€	1.472€	1.655€	1.749€	2.258€	2.504€	2.950€	3.149€	3.306€
450 CM	1.244€	1.515€	1.778€	1.995€	2.240€	2.457€	2.763€	3.272€	3.488€	3.629€
500 CM	1.333€	1.621€	1.901€	2.160€	2.457€	2.852€	2.933€	3.480€	3.718€	3.857€
550 CM	1.583€	1.909€	1.901€	2.555€	2.933€	3.480€	3.603€	4.197€	4.418€	4.625€
600 CM	1.638€	1.977€	1.901€	2.729€	3.149€	3.718€	4.014€	4.486€	4.791€	5.029€

## OPTION

Gerade Dachrinnenleiste  
€ 15,- per meter

Maßanfertigung  
Polycarbonat € 100,- zzgl.

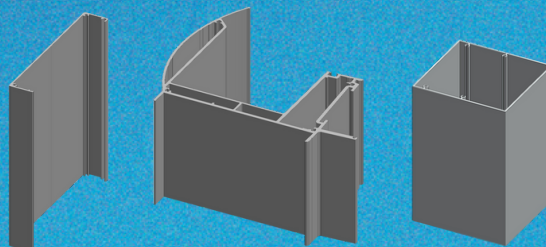

## STANDARDFARBEN

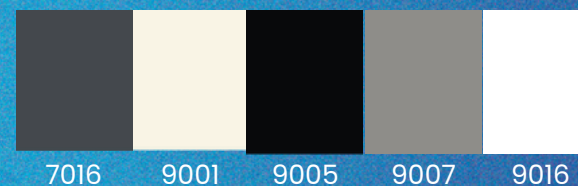

## POLYCARBONAT



# PRIME PLUS + R-LINE KLARGLAS

**Bis zu 5m. nur 2 Pfosten!**

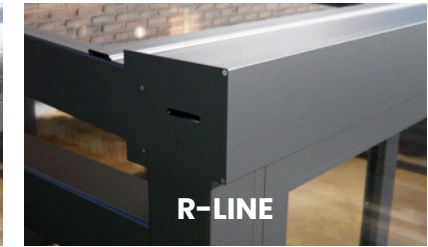

VSG Klar	300 CM	400 CM	506 CM	606 CM	706 CM	806 CM	906 CM	1006 CM	1106 CM	1206 CM
200 CM	1.050€	1.298€	1.471€	1.645€	1.870€	2.043€	2.378€	2.605€	2.908€	3.202€
250 CM	1.269€	1.420€	1.630€	1.824€	2.042€	2.244€	2.623€	2.839€	3.215€	3.462€
300 CM	1.420€	1.630€	1.861€	2.008€	2.276€	2.513€	2.908€	3.150€	3.393€	3.635€
350 CM	1.756€	2.025€	2.285€	2.571€	2.813€	3.101€	3.566€	3.941€	4.244€	4.501€
400 CM	1.982€	2.294€	2.492€	2.933€	3.184€	3.445€	4.042€	4.479€	4.798€	5.201€
450 CM	2.223€	2.588€	3.059€	3.621€	4.280€	4.853€	5.652€	6.074€	6.565€	6.880€

## OPTION

Gerade Dachrinnenleiste  
€ 15,- per meter

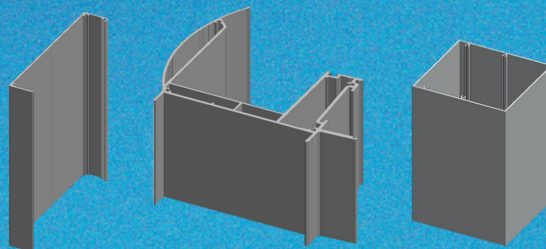

## STANDARDFARBEN

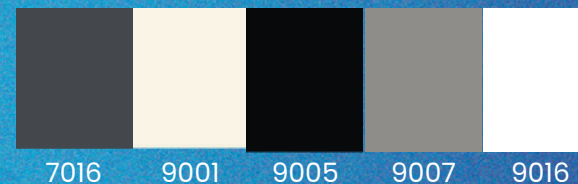

## 8 MM VSG / 44.2 GLAS



# PRIME PLUS + R-LINE OPALGLAS

**Bis zu 5m. nur 2 Pfosten!**



PRIME PLUS

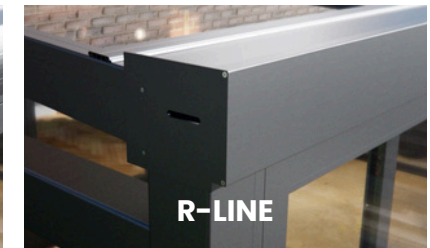

R-LINE

Opalglas	300 CM	400 CM	506 CM	606 CM	706 CM	806 CM	906 CM	1006 CM	1106 CM	1206 CM
200 CM	1.203€	1.393€	1.610€	1.800€	2.008€	2.242€	2.584€	2.817€	3.100€	3.517€
250 CM	1.403€	1.627€	1.870€	2.095€	2.311€	2.536€	2.770€	3.079€	3.220€	3.739€
300 CM	1.618€	1.852€	2.138€	2.363€	2.605€	2.874€	3.142€	3.410€	3.679€	3.947€
350 CM	1.922€	2.242€	2.441€	2.882€	3.220€	3.575€	3.955€	4.310€	4.666€	5.020€
400 CM	2.164€	2.510€	2.856€	3.220€	3.557€	3.929€	4.545€	4.968€	5.366€	5.799€
450 CM	2.429€	2.815€	3.221€	3.817€	4.506€	5.113€	5.937€	6.397€	6.924€	7.279€

## OPTION

Gerade Dachrinnenleiste  
€ 15,- per meter

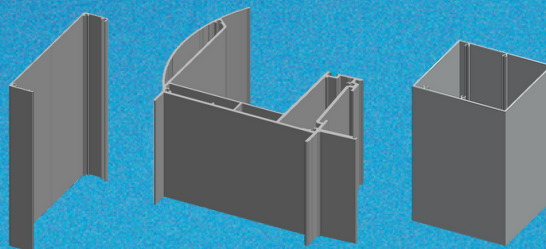

## STANDARDFARBEN

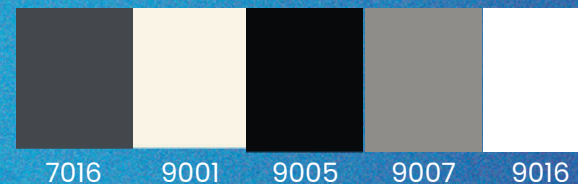

## 8 MM VSG / 44.2 GLAS



# PRIME PLUS + R-LINE GETÖNTESGLAS

**Bis zu 5m. nur 2 Pfosten!**

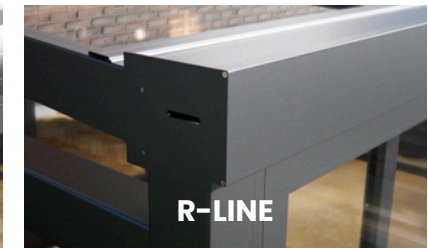

Getöntes	300 CM	400 CM	506 CM	606 CM	706 CM	806 CM	906 CM	1006 CM	1106 CM	1206 CM
200 CM	1.350€	1.602€	1.844€	2.095€	2.389€	2.640€	3.055€	3.324€	3.583€	3.843€
250 CM	1.558€	1.800€	2.095€	2.380€	2.735€	3.021€	3.523€	3.834€	4.146€	4.457€
300 CM	1.775€	2.069€	2.337€	2.675€	3.072€	3.428€	3.982€	4.354€	4.674€	5.064€
350 CM	2.146€	2.640€	3.021€	3.488€	4.025€	4.492€	5.271€	5.782€	6.284€	6.786€
400 CM	2.432€	3.003€	3.445€	3.999€	4.605€	5.150€	6.059€	6.639€	7.227€	7.816€
450 CM	2.731€	3.370€	3.950€	4.690€	5.522€	6.273€	7.242€	7.846€	8.516€	9.016€

## OPTION

Gerade Dachrinnenleiste  
€ 15,- per meter

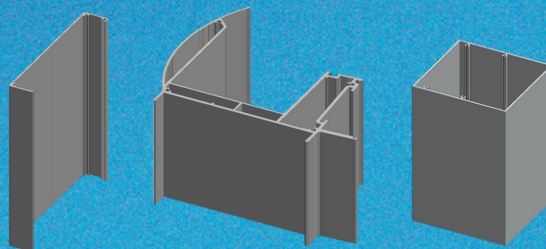

## STANDARDFARBEN

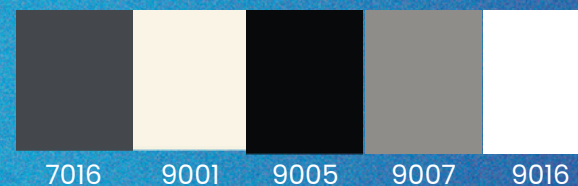

## 8 MM VSG / 44.2 GLAS



# DIAMOND OHNEGLAS



**Bis zu 6m. nur 2 Pfosten !**



Ohneglas	300 CM	400 CM	506 CM	606 CM	706 CM	806 CM	906 CM	1006 CM	1106 CM	1206 CM
200 CM	1.046€	1.161€	1.277€	1.393€	1.569€	1.682€	1.940€	2.076€	2.201€	2.529€
250 CM	1.192€	1.277€	1.412€	1.516€	1.661€	1.786€	1.905€	2.224€	2.360€	2.498€
300 CM	1.310€	1.403€	1.516€	1.571€	1.744€	1.917€	2.281€	2.373€	2.529€	2.688€
350 CM	1.586€	1.748€	1.899€	2.061€	2.217€	2.348€	2.808€	3.001€	3.214€	3.428€
400 CM	1.782€	1.891€	2.035€	2.357€	2.460€	2.629€	3.156€	3.440€	3.650€	3.945€
450 CM	1.995€	2.230€	2.878€	3.327€	3.471€	3.720€	4.524€	4.926€	5.157€	5.608€

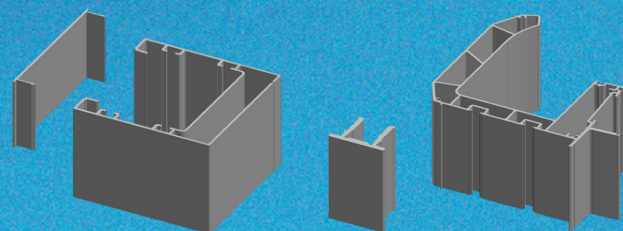

## STANDARDFARBEN

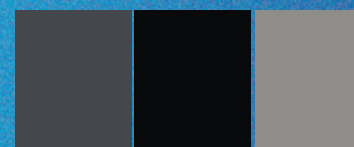

7016 9005 9007

## 8 MM VSG / 44.2 GLAS



Klar Getönt Opal

# DIAMOND POLYCARBONAT



**Bis zu 6m. nur 2 Pfosten !**

POLY	300 CM	400 CM	506 CM	606 CM	706 CM	806 CM	906 CM	1006 CM	1106 CM	1206 CM
200 CM	884€	1.021€	1.200€	1.338€	1.486€	1.696€	1.823€	2.140€	1.952€	2.441€
250 CM	981€	1.169€	1.349€	1.516€	1.696€	1.951€	2.104€	2.430€	2.518€	2.727€
300 CM	1.108€	1.317€	1.486€	1.624€	1.803€	2.073€	2.221€	2.579€	2.696€	2.886€
350 CM	1.236€	1.435€	1.613€	1.823€	1.992€	2.400€	2.599€	3.074€	3.284€	3.473€
400 CM	1.307€	1.578€	1.772€	1.992€	2.104€	2.717€	3.013€	3.549€	3.789€	3.978€
450 CM	1.497€	1.823€	2.140€	2.400€	2.696€	2.957€	3.325€	3.937€	4.198€	4.366€
500 CM	1.604€	1.951€	2.288€	2.599€	2.957€	3.432€	3.529€	4.188€	4.473€	4.642€
550 CM	1.905€	2.298€	2.696€	3.074€	3.529€	4.188€	4.336€	5.050€	5.316€	5.566€
600 CM	1.971€	2.379€	2.865€	3.284€	3.789€	4.473€	4.831€	5.398€	5.765€	6.052€

## OPTION

Maßanfertigung  
Polycarbonat € 100,- zzgl.

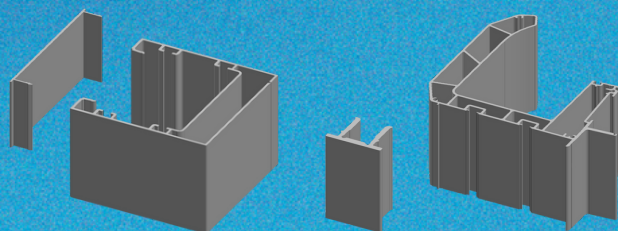

## STANDARDFARBEN

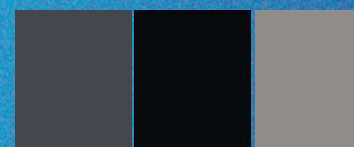

7016 9005 9007

## POLYCARBONAT

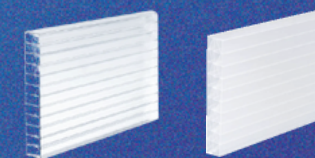

Klar Opal

# DIAMOND KLARGLAS



**Bis zu 6m. nur 2 Pfosten !**



VSG Klar	300 CM	400 CM	506 CM	606 CM	706 CM	806 CM	906 CM	1006 CM	1106 CM	1206 CM
200 CM	1.298€	1.497€	1.697€	1.897€	2.157€	2.354€	2.697€	2.916€	3.125€	3.538€
250 CM	1.508€	1.697€	1.937€	2.146€	2.397€	2.626€	2.850€	3.274€	3.515€	3.759€
300 CM	1.688€	1.907€	2.146€	2.327€	2.626€	2.925€	3.415€	3.634€	3.915€	4.201€
350 CM	2.027€	2.336€	2.634€	2.943€	3.246€	3.524€	4.131€	4.471€	4.832€	5.192€
400 CM	2.287€	2.563€	2.876€	3.366€	3.636€	3.973€	4.669€	5.121€	5.499€	5.961€
450 CM	2.562€	2.987€	3.562€	4.159€	4.479€	4.895€	5.814€	6.369€	6.768€	7.367€

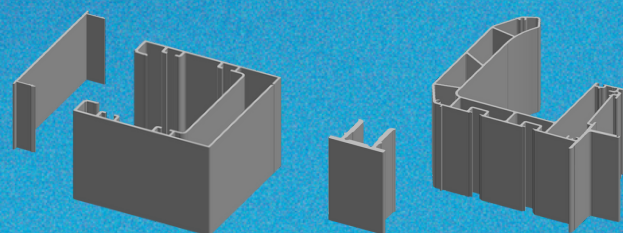

## STANDARDFARBEN



7016 9005 9007

## 8 MM VSG / 44.2 GLAS



Klar Getönt Opal

# DIAMOND OPALGLAS



**Bis zu 6m. nur 2 Pfosten !**



Opalglas	300 CM	400 CM	506 CM	606 CM	706 CM	806 CM	906 CM	1006 CM	1106 CM	1206 CM
<b>200 CM</b>	1.388€	1.608€	1.856€	2.076€	2.317€	2.595€	2.835€	3.060€	3.279€	3.496€
<b>250 CM</b>	1.618€	1.876€	2.157€	2.417€	2.667€	2.932€	3.076€	3.340€	3.715€	3.976€
<b>300 CM</b>	1.867€	2.136€	2.466€	2.725€	3.005€	3.315€	3.622€	3.933€	4.235€	4.554€
<b>350 CM</b>	2.217€	2.587€	2.808€	3.328€	3.707€	4.133€	4.563€	5.384€	5.384€	5.795€
<b>400 CM</b>	1.656€	2.895€	3.295€	3.714€	4.103€	4.524€	5.242€	5.720€	6.198€	6.683€
<b>450 CM</b>	2.727€	3.161€	3.954€	4.452€	4.944€	5.444€	6.271€	6.858€	7.431€	8.024€

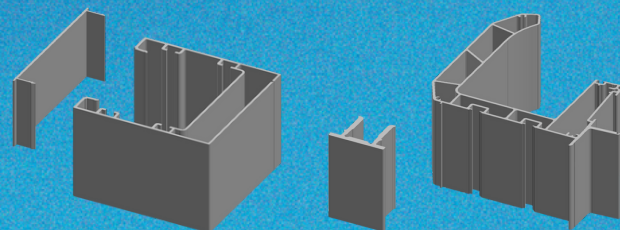

## STANDARDFARBEN

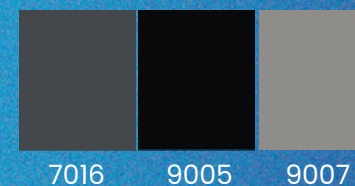

## 8 MM VSG / 44.2 GLAS



# DIAMOND GETÖNTESGLAS



**Bis zu 6m. nur 2 Pfosten !**



Getöntes	300 CM	400 CM	506 CM	606 CM	706 CM	806 CM	906 CM	1006 CM	1106 CM	1206 CM
<b>200 CM</b>	1.558€	1.848€	2.118€	2.417€	2.755€	3.046€	3.641€	3.882€	4.260€	4.434€
<b>250 CM</b>	1.797€	2.076€	2.417€	2.740€	3.156€	3.485€	4.064€	4.774€	4.783€	5.141€
<b>300 CM</b>	2.047€	2.378€	2.693€	3.077€	3.550€	3.954€	4.590€	5.375€	5.392€	5.848€
<b>350 CM</b>	2.476€	3.046€	3.485€	4.024€	4.644€	5.192€	6.081€	6.678€	7.250€	7.828€
<b>400 CM</b>	2.805€	3.464€	3.973€	4.618€	5.312€	5.949€	7.003€	7.656€	8.329€	9.017€
<b>450 CM</b>	3.010€	3.718€	4.250€	5.440€	6.069€	6.569€	8.221€	8.995€	9.780€	10.610€

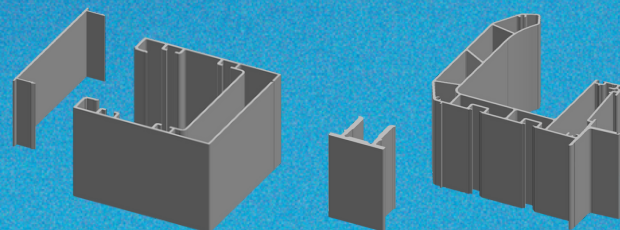

## STANDARDFARBEN

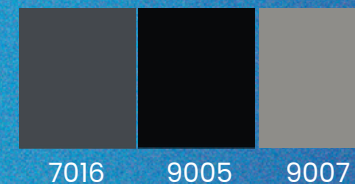

## 8 MM VSG / 44.2 GLAS



# CUBOLINE



**Bis zu 7m. nur 2 Pfosten !**

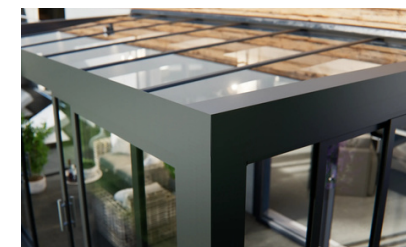

Ohneglas	300 CM	400 CM	500 CM	600 CM	700 CM	800 CM	900 CM	1000 CM	1100 CM	1200 CM
300 CM	2.260€	2.596€	2.932€	3.269€	3.768€	4.096€	4.423€	4.739€	5.067€	5.384€
350 CM	2.610€	3.057€	3.504€	3.951€	4.543€	4.971€	5.408€	5.835€	6.272€	6.701€
400 CM	2.941€	3.461€	3.989€	4.519€	5.163€	5.672€	6.181€	6.681€	7.192€	7.691€
450 CM	3.639€	4.393€	5.148€	5.903€	6.917€	7.451€	8.186€	8.921€	9.637€	10.383€
500 CM	4.000€	4.832€	5.663€	6.493€	7.609€	8.196€	9.000€	9.813€	10.601€	11.421€

VSG Klar	300 CM	400 CM	500 CM	600 CM	700 CM	800 CM	900 CM	1000 CM	1100 CM	1200 CM
300 CM	2.588€	3.050€	3.512€	3.974€	4.594€	5.047€	5.500€	5.943€	6.397€	6.840€
350 CM	2.995€	3.587€	4.178€	4.770€	5.500€	6.073€	6.655€	7.228€	7.811€	8.384€
400 CM	3.384€	4.067€	4.761€	5.454€	6.258€	6.933€	7.608€	8.273€	8.947€	9.613€
450 CM	4.123€	5.057€	5.990€	6.923€	8.107€	8.828€	9.743€	10.658€	11.554€	12.480€
500 CM	4.535€	5.563€	6.589€	7.615€	8.918€	9.711€	10.717€	11.724€	12.709€	13.728€

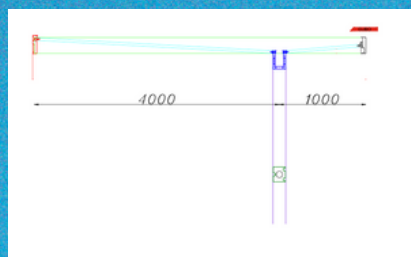
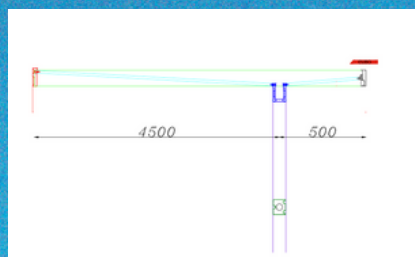

## STANDARDFARBEN



7016 9005

## 8 MM VSG / 44.2 GLAS



Klar Getönt Opal

# CUBOLINE



**Bis zu 7m. nur 2 Pfosten !**

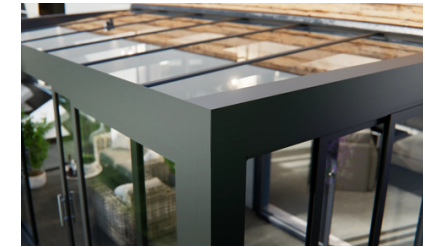

Opalglas	300 CM	400 CM	500 CM	600 CM	700 CM	800 CM	900 CM	1000 CM	1100 CM	1200 CM
300 CM	2.681€	3.189€	3.680€	4.178€	4.826€	5.306€	5.796€	6.277€	6.766€	7.247€
350 CM	3.189€	3.836€	4.492€	5.139€	5.916€	6.554€	7.192€	7.830€	8.458€	9.115€
400 CM	3.596€	4.345€	5.112€	5.870€	6.739€	7.478€	8.227€	9.012€	9.706€	10.446€
450 CM	4.437€	5.491€	6.535€	7.570€	8.865€	9.678€	10.695€	11.712€	12.728€	13.681€
500 CM	4.881€	6.040€	7.189€	8.327€	9.752€	10.646€	11.765€	12.883€	14.000€	15.049€

Getöntes	300 CM	400 CM	500 CM	600 CM	700 CM	800 CM	900 CM	1000 CM	1100 CM	1200 CM
300 CM	3.235€	3.911€	4.585€	5.269€	6.064€	6.720€	7.385€	8.042€	8.716€	9.382€
350 CM	4.030€	4.964€	5.897€	6.840€	7.847€	8.763€	9.678€	10.593€	11.508€	12.423€
400 CM	4.557€	5.639€	6.720€	7.765€	8.947€	10.001€	11.055€	12.109€	13.173€	14.235€
450 CM	5.962€	7.488€	9.059€	10.538€	12.387€	13.626€	15.465€	16.639€	18.118€	19.689€
500 CM	6.558€	8.237€	9.965€	11.592€	13.626€	14.989€	17.012€	18.303€	19.930€	21.658€

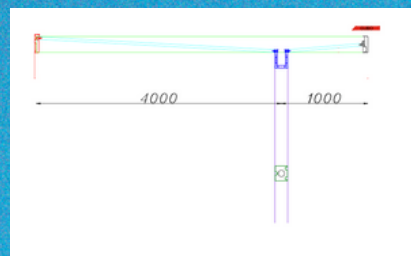
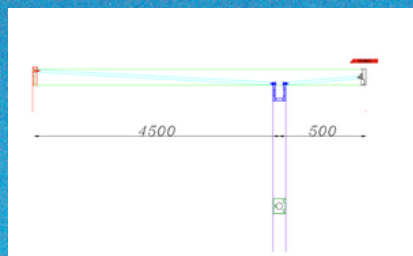

## STANDARDFARBEN



7016 9005

## 8 MM VSG / 44.2 GLAS



Klar Getönt Opal

# CARPORT



Carport	250 CM	300 CM	350 CM	400 CM
250 CM	2.664€	2.784€	3.038€	3.157€
300 CM	2.784€	2.903€	3.157€	3.276€
350 CM	3.038€	3.157€	3.456€	3.575€
400 CM	3.157€	3.276€	3.575€	3.694€
450 CM	3.411€	3.530€	3.874€	3.993€
500 CM	3.530€	3.649€	3.993€	4.113€
550 CM	3.784€	3.903€	4.293€	4.412€
600 CM	3.903€	4.023€	4.412€	4.531€
650 CM	4.892€	5.038€	5.500€	5.647€
700 CM	5.011€	5.157€	5.619€	5.766€
750 CM	5.265€	5.412€	5.918€	6.065€
800 CM	5.384€	5.531€	6.037€	6.184€
850 CM	5.638€	5.785€	6.337€	6.483€
900 CM	5.757€	5.904€	6.456€	6.602€
950 CM	6.011€	6.158€	6.755€	6.902€
1000 CM	6.131€	6.277€	6.874€	7.021€

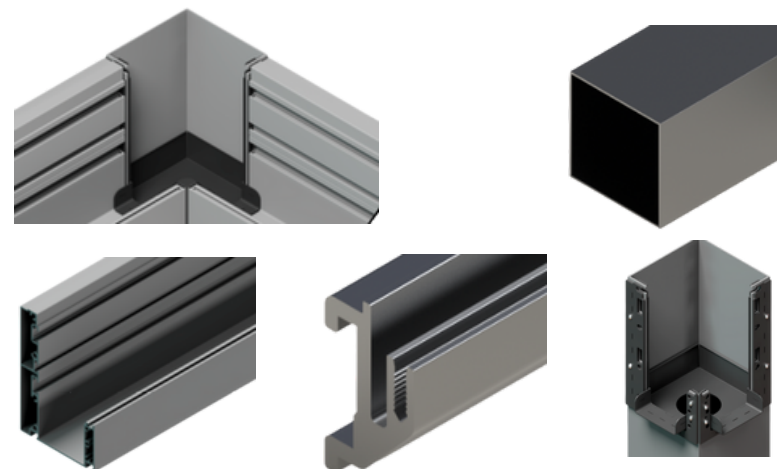
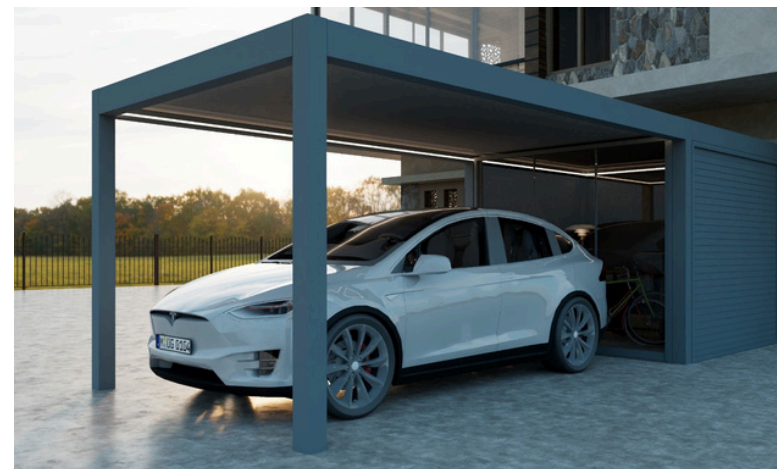

**STANDARDFARBE**



7016

**SANDWICHPANEELE**

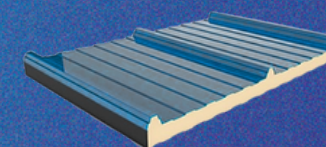

# GLAS-SCHIEBEWÄNDE

## ESG 10 MM

Preise inkl. U-Profile (Glaseinzug) | Zugluftstreifen | 1 x Griff



### 2-SCHIENEN

**Klarglas**  
€ 303,-

**GETÖNTESGLAS**  
€ 353,-



### 3-SCHIENEN

**Klarglas**  
€ 454,-

**GETÖNTESGLAS**  
€ 529,-



### 4-SCHIENEN

**Klarglas**  
€ 605,-

**GETÖNTESGLAS**  
€ 706,-



### 5-SCHIENEN

**Klarglas**  
€ 756,-

**GETÖNTESGLAS**  
€ 882,-



### 6-SCHIENEN

**Klarglas**  
€ 908,-

**GETÖNTESGLAS**  
€ 1059,-



### 7-SCHIENEN

**Klarglas**  
€ 1059,-

**GETÖNTESGLAS**  
€ 1235,-

#### TEILE

Belüftungsstreifen	p.stuk	€8
Scheibenmitnehmer	p.stuk	€4
Schließsystem	p. stuk	€143
Griff / Türgriff	p.stuk	€8
Laufwagen	p.stuk	€21
Klarglas	p. m2	€38
Getöntes	p.m2	€55
Glassystem	p.mt	€84

Aufpreis von 15 € pro Scheibe für  
Gläser über 240 cm

#### GLASMASSE

900   1900 bis 2500
980   1900 bis 2500
1030   1900 bis 2500

#### STANDARDFARBEN

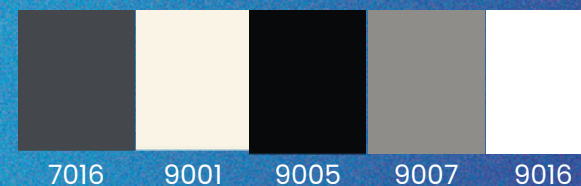

#### GLAS 10MM



# SEITENELEMENTE



**SEITENKEIL POLY**

200 CM	<b>€76,-</b>
250 CM	<b>€84,-</b>
300 CM	<b>€97,-</b>
350 CM	<b>€118,-</b>
400 CM	<b>€134,-</b>
450 CM	<b>€151,-</b>
500 CM	<b>€168,-</b>
550 CM	<b>€185,-</b>
600 CM	<b>€202,-</b>

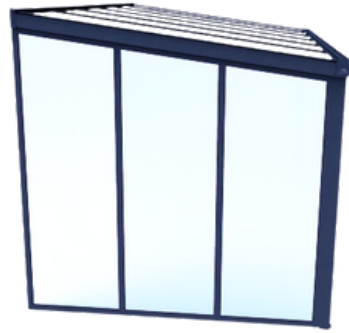

**SEITENWAND POLY**

200 CM	<b>€235,-</b>
250 CM	<b>€269,-</b>
300 CM	<b>€286,-</b>
350 CM	<b>€336,-</b>
400 CM	<b>€370,-</b>
450 CM	<b>€412,-</b>
500 CM	<b>€437,-</b>
550 CM	<b>€471,-</b>
600 CM	<b>€504,-</b>



**ALU SEITENWAND**

180x200 CM	<b>€286,-</b>
180x250 CM	<b>€353,-</b>
180x300 CM	<b>€420,-</b>
180x350 CM	<b>€487,-</b>
180x400 CM	<b>€555,-</b>
180x450 CM	<b>€622,-</b>
180x500 CM	<b>€689,-</b>
180x550 CM	<b>€756,-</b>
180x600 CM	<b>€824,-</b>



**ALU-AKUSTIKPANEEL ALUWALL**

180x200 CM	<b>€303,-</b>
180x250 CM	<b>€374,-</b>
180x300 CM	<b>€445,-</b>
180x350 CM	<b>€517,-</b>
180x400 CM	<b>€588,-</b>
180x450 CM	<b>€660,-</b>
180x500 CM	<b>€731,-</b>
180x550 CM	<b>€803,-</b>
180x600 CM	<b>€874,-</b>

# ZUBEHÖR

## BELEUCHTUNG

KALT	<b>pro Stück €13,-</b>
WARM	<b>pro Stück €13,-</b>
WARM 10 DIMMBAR	<b>SET €210,-</b>
WARM 12 DIMMBAR	<b>SET €252,-</b>

## ALUMINIUMPROFILE

F-PROFIL	<b>p.M. 5,00 €</b>
U-PROFIL	<b>p.M. 4,00 €</b>
H-PROFIL	<b>p.M. 8,00 €</b>
ALUWAND LOS	<b>p.M. 11,00 €</b>
ALUWALL LOS	<b>p.M. 13,00 €</b>
HOHLPRF. 120x60	<b>p.M. 21,00 €</b>
HOHLPRF. 100x50	<b>p.M. 13,00 €</b>
L-PROFIL 40x20	<b>p.M. 4,00 €</b>
L-PROFIL 60x20	<b>p.M. 5,00 €</b>

## VERANDA-PROFILE

PPLUS-RIINE	<b>p.M. 59 €</b>
WANDANSCHLUSS	<b>p.M. 29 €</b>
SPARREN	<b>p.M. 17 €</b>
XL SPAREN	<b>p.M. 22 €</b>
ABDECKLEISTE	<b>p.M. 10 €</b>
SEITENABDECKLEISTE	<b>p.M. 11 €</b>
PFOSTEN 250 CM	<b>pro Stück 84 €</b>
DISTANZPROFIL	<b>p.M. 8 €</b>
FREISTEHEND PROF.	<b>p.M. 59 €</b>
Verstärkungsrinne 600 CM	<b>Pro Stück 126€</b>
FUNDAMENTFUSS	<b>pro Stück 13 €</b>
POLYCARBONAT 16 MM	<b>p/m² 21 €</b>
GERADE RINNENKAPPE	<b>p.M. €13,-</b>

## INFO

Beleuchtung wird eingebaut/verdrahtet geliefert

## STANDARDFARBEN

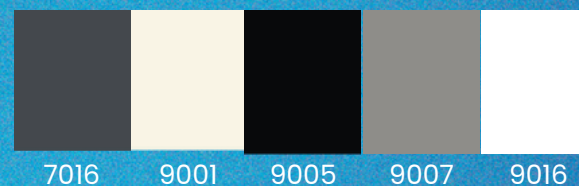

## POLYCARBONAT



# ALUMINIUM RAHMEN WD55

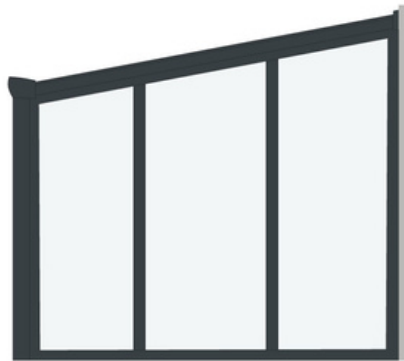

## SEITENKEIL GLAS

<b>250 CM</b>	€ 336		<b>350 CM</b>	€ 487		<b>450 CM</b>	€ 664
<b>300 CM</b>	€ 412		<b>400 CM</b>	€ 571		<b>500 CM</b>	€ 773

## SEITENWAND GLAS

<b>250 CM</b>	€ 1008		<b>350 CM</b>	€ 1176		<b>450 CM</b>	€ 1345
<b>300 CM</b>	€ 1092		<b>400 CM</b>	€ 1261		<b>500 CM</b>	€ 1429

## INFO

Im Preis enthalten  
44.2 klares Verbundglas

## STANDARDFARBEN

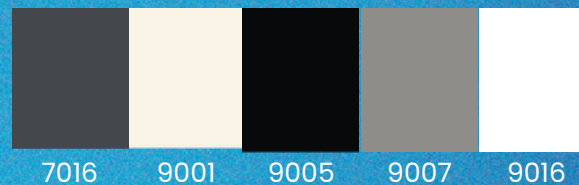

## GLAS



# ALUMINIUM SCHIEBETÜR



**SCHIEBETÜR 2-TEILIG TS100**

<b>300 CM</b>	€ 1450
<b>400 CM</b>	€ 1643

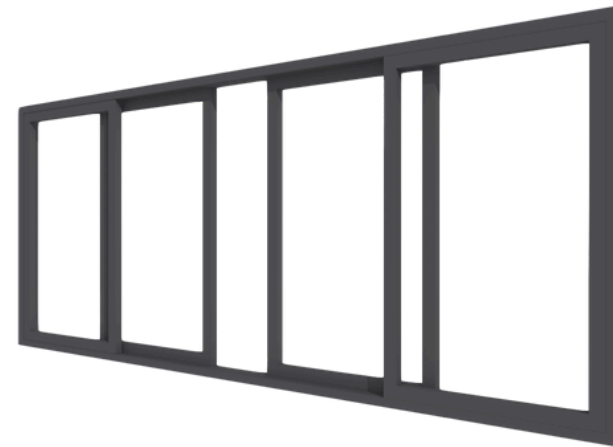

**SCHIEBETÜR 4-TEILIG TS100**

<b>400 CM</b>	€ 1933
<b>500 CM</b>	€ 2078
<b>600 CM</b>	€ 2174
<b>700 CM</b>	€ 2512

## INFO TS100

Die Preise beinhalten 44,2 klares Verbundglas

inklusive Scharniere und Schlösser

Es handelt sich um eine nicht isolierte Schiebetür

## STANDARDFARBEN



7016 9001 9005

## OPTION

Höher als 250 cm Aufpreis 250,€

Lüftungsgitter: 1,50 € pro CM

# ALUMINIUM RAHMEN WD55



**FESTELEMENT**

<b>50x50</b>	€277
<b>100x100</b>	€307
<b>100x200</b>	€353
<b>100x300</b>	€454
<b>200x200</b>	€513
<b>200x300</b>	€613



**DREHEN KIPPEN**

<b>80x80</b>	€588
<b>100x100</b>	€672

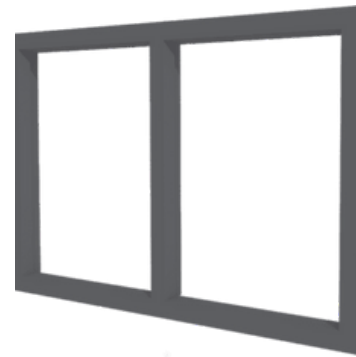

**FEST 2-TEILIG**

<b>150x100</b>	€416
<b>200x150</b>	€487
<b>150x300</b>	€559



**FEST 3-TEILIG**

<b>150x200</b>	€580
<b>200x300</b>	€723



**TÜR**

<b>100x220</b>	€966
<b>100x250</b>	€1050

## INFO

Im Preis enthalten  
44.2 klares Verbundglas

## STANDARDFARBEN



7016 9001 9005

## GLAS

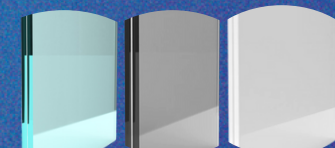

Klar Getönt Opal

# MARKISE

somfy. Serge Ferrari

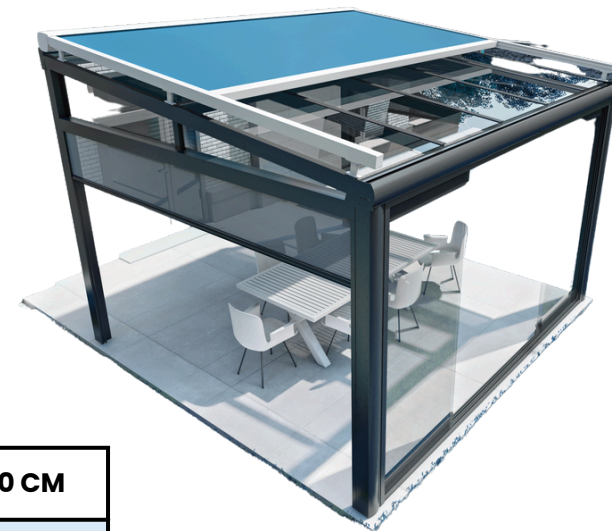

	300 CM	350 CM	400 CM	450 CM	500 CM	550 CM	600 CM
250 CM	1.555€	1.605€	1.655€	1.807€	1.916€	1.958€	2.017€
300 CM	1.597€	1.643€	1.697€	1.891€	1.975€	2.017€	2.059€
350 CM	1.630€	1.685€	1.735€	1.933€	2.017€	2.059€	2.143€
400 CM	1.664€	1.723€	1.756€	1.975€	2.059€	2.143€	2.353€
450 CM	1.739€	1.824€	1.849€	2.017€	2.125€	2.210€	2.563€
500 CM	1.824€	1.891€	1.933€	2.059€	2.168€		

100% Solarenergie  
Ohne Kabel

Solar + € 125,-  
Somfy Solar + € 210



## INFO

Unterkonstruktion: + € 50,-

Stoffart: Serge Ferrari Soltis 92 Perform

Bedienung: Elektrischer SOMFY IO-Motor  
mit Fernbedienung

Fernbedienung:  
1-Kanal €45  
5-Kanal €85  
16-Kanal € 145

Optional: in mehreren  
Farben erhältlich 5% mehr Aufpreis

## STANDARDFARBEN

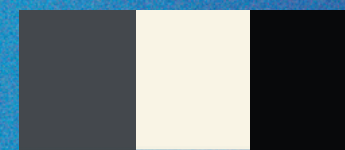

7016

9001

9005

## STANDARDTÜCHER

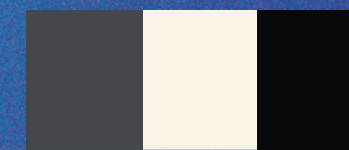

92-  
2047

92-  
2044

B92-  
2053

# SENKRECHTMARKISE

somfy. Serge Ferrari

	150 CM	200 CM	250 CM	300 CM	350 CM	400 CM	450 CM	500 CM	550 CM
150 CM	630€	672€	723€	773€	824€	874€	924€	975€	1.042€
200 CM	664€	706€	756€	807€	866€	916€	1.017€	1.076€	1.134€
250 CM	706€	756€	824€	908€	975€	1.042€	1.109€	1.168€	1.252€
275 CM	723€	782€	866€	933€	1.017€	1.084€	1.151€	1.210€	1.311€
300 CM	748€	824€	908€	975€	1.059€	1.126€	1.193€	1.252€	1.336€



100% Solarenergie  
Ohne Kabel

Solar + € 125,-  
Somfy Solar + € 210



## INFO

Stoffart:  
Serge Ferrari Veozip

Bedienung: Elektrischer SOMFY IO-Motor  
mit Fernbedienung

Fernbedienung:  
1-Kanal €45  
5-Kanal €85  
16-Kanal € 145

Optional: in mehreren  
Farben erhältlich 5% mehr Aufpreis

## STANDARDFARBEN

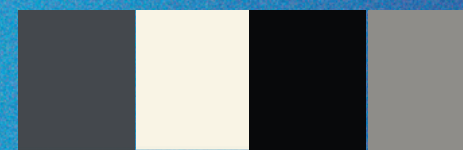

7016 9001 9005 9007

## STANDARDTÜCHER

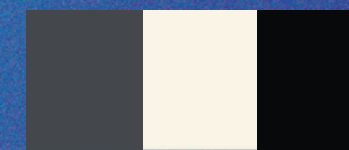

7605-51194 7605-51184 7605-51198

# CLIMATIC FORTE

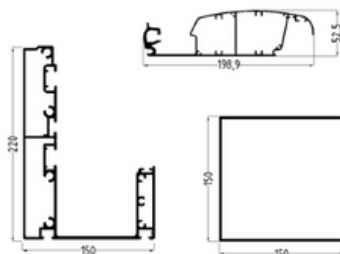

CM	200	225	250	275	300	325	350	375	400	425	450	Anzahl der Klängen
<b>203</b>	3,686€	3,821€	3,955€	4,089€	4,224€	4,358€	4,492€	4,627€	4,782€	4,938€	5,093€	10
<b>220</b>	3,818€	3,961€	4,104€	4,247€	4,389€	4,532€	4,675€	4,818€	4,981€	5,144€	5,307€	11
<b>237</b>	3,950€	4,101€	4,253€	4,404€	4,555€	4,706€	4,858€	5,009€	5,180€	5,351€	5,522€	12
<b>254</b>	4,082€	4,242€	4,401€	4,561€	4,721€	4,881€	5,041€	5,200€	5,379€	5,557€	5,736€	13
<b>271</b>	4,213€	4,382€	4,550€	4,718€	4,887€	5,055€	5,223€	5,392€	5,578€	5,764€	5,950€	14
<b>288</b>	4,345€	4,522€	4,699€	4,876€	5,052€	5,229€	5,406€	5,583€	5,777€	5,970€	6,164€	15
<b>305</b>	4,477€	4,662€	4,848€	5,033€	5,218€	5,403€	5,589€	5,774€	5,976€	6,177€	6,378€	16
<b>322</b>	4,609€	4,803€	4,996€	5,190€	5,384€	5,578€	5,772€	5,965€	6,174€	6,384€	6,593€	17
<b>339</b>	4,740€	4,943€	5,145€	5,347€	5,550€	5,752€	5,954€	6,157€	6,373€	6,590€	6,807€	18

CM	200	225	250	275	300	325	350	375	400	425	450	Anzahl der Klängen
<b>373</b>	5,004€	5,223€	5,443€	5,662€	5,881€	6,100€	6,320€	6,539€	6,771€	7,003€	7,235€	20
<b>390</b>	5,136€	5,364€	5,591€	5,819€	6,047€	6,275€	6,503€	6,730€	6,970€	7,210€	7,449€	21
<b>407</b>	5,267€	5,504€	5,740€	5,976€	6,213€	6,449€	6,685€	6,922€	7,169€	7,416€	7,664€	22
<b>424</b>	5,398€	5,644€	5,889€	6,134€	6,378€	6,623€	6,868€	7,113€	7,368€	7,623€	7,878€	23
<b>441</b>	5,530€	5,784€	6,038€	6,291€	6,544€	6,797€	7,051€	7,304€	7,567€	7,829€	8,092€	24
<b>458</b>	5,662€	5,925€	6,186€	6,448€	6,710€	6,972€	7,234€	7,495€	7,766€	8,036€	8,306€	25
<b>475</b>	5,794€	6,065€	6,335€	6,605€	6,876€	7,146€	7,416€	7,687€	7,965€	8,242€	8,520€	26
<b>492</b>	5,925€	6,205€	6,484€	6,763€	7,041€	7,320€	7,599€	7,878€	8,163€	8,449€	8,735€	27
<b>509</b>	6,057€	6,345€	6,633€	6,920€	7,207€	7,494€	7,782€	8,069€	8,362€	8,656€	8,949€	28
<b>526</b>	6,188€	6,486€	6,781€	7,077€	7,373€	7,669€	7,965€	8,260€	8,561€	8,862€	9,163€	29
<b>543</b>	6,320€	6,626€	6,930€	7,234€	7,539€	7,834€	8,130€	8,426€	8,760€	9,094€	9,428€	30
<b>560</b>	6,452€	6,766€	7,079€	7,392€	7,704€	8,017€	8,330€	8,643€	8,959€	9,275€	9,591€	31
<b>577</b>	6,583€	6,906€	7,228€	7,549€	7,870€	8,191€	8,513€	8,834€	9,158€	9,482€	9,806€	32
<b>594</b>	6,715€	7,047€	7,376€	7,706€	8,036€	8,366€	8,696€	9,025€	9,357€	9,688€	10,020€	33
<b>611</b>	6,847€	7,187€	7,525€	7,863€	8,202€	8,540€	8,878€	9,217€	9,556€	9,895€	10,234€	34
<b>2 motoren</b>	<b>200</b>	<b>225</b>	<b>250</b>	<b>275</b>	<b>300</b>	<b>325</b>	<b>350</b>	<b>375</b>	<b>400</b>	<b>425</b>	<b>450</b>	<b>Anzahl der Klängen</b>
<b>615</b>	7,580€	7,923€	8,265€	8,608€	8,951€	9,293€	9,635€	9,977€	10,320€	10,662€	11,005€	33
<b>632</b>	7,709€	8,053€	8,396€	8,740€	9,084€	9,463€	9,814€	10,165€	10,516€	10,867€	11,091€	34
<b>649</b>	7,837€	8,184€	8,526€	8,872€	9,217€	9,602€	9,993€	10,353€	10,713€	11,072€	11,431€	35
<b>666</b>	7,965€	8,314€	8,657€	9,002€	9,352€	9,805€	10,173€	10,541€	10,908€	11,276€	11,644€	36

2 motoren	200	225	250	275	300	325	350	375	400	425	450	Anzahl der Klängen
<b>683</b>	8,094€	8,444€	8,787€	9,132€	9,485€	9,939€	10,352€	10,729€	11,104€	11,481€	11,849€	37
<b>700</b>	8,223€	8,607€	8,992€	9,376€	9,761€	10,146€	10,531€	10,916€	11,301€	11,685€	12,070€	38
<b>717</b>	8,351€	8,744€	9,138€	9,530€	9,924€	10,316€	10,710€	11,104€	11,496€	11,890€	12,283€	39
<b>734</b>	8,480€	8,881€	9,283€	9,684€	10,086€	10,483€	10,889€	11,291€	11,693€	12,094€	12,496€	40
<b>751</b>	8,608€	9,018€	9,428€	9,838€	10,248€	10,658€	11,069€	11,478€	11,888€	12,299€	12,708€	41
<b>768</b>	8,736€	9,155€	9,574€	9,992€	10,411€	10,829€	11,247€	11,666€	12,084€	12,503€	12,922€	42
<b>785</b>	8,865€	9,292€	9,719€	10,146€	10,573€	11,000€	11,427€	11,854€	12,281€	12,708€	13,134€	43
<b>802</b>	8,993€	9,429€	9,864€	10,299€	10,735€	11,171€	11,606€	12,043€	12,476€	12,912€	13,348€	44
<b>819</b>	9,122€	9,566€	10,010€	10,453€	10,897€	11,342€	11,785€	12,229€	12,673€	13,116€	13,560€	45
<b>836</b>	9,251€	9,703€	10,155€	10,607€	11,059€	11,512€	11,964€	12,416€	12,869€	13,321€	13,773€	46
<b>853</b>	9,379€	9,840€	10,300€	10,761€	11,222€	11,682€	12,143€	12,604€	13,065€	13,525€	13,986€	47
<b>870</b>	9,507€	9,976€	10,446€	10,915€	11,384€	11,853€	12,322€	12,792€	13,261€	13,730€	14,199€	48
<b>887</b>	9,636€	10,113€	10,591€	11,069€	11,546€	12,024€	12,502€	12,980€	13,456€	13,934€	14,412€	49
<b>904</b>	9,765€	10,250€	10,736€	11,223€	11,709€	12,195€	12,680€	13,167€	13,653€	14,139€	14,625€	50
<b>921</b>	9,893€	10,387€	10,882€	11,376€	11,871€	12,365€	12,860€	13,354€	13,849€	14,343€	14,838€	51
<b>938</b>	10,022€	10,524€	11,027€	11,530€	12,033€	12,536€	13,039€	13,542€	14,045€	14,548€	15,051€	52
<b>955</b>	10,150€	10,662€	11,172€	11,684€	12,195€	12,707€	13,218€	13,729€	14,241€	14,752€	15,263€	53
<b>972</b>	10,278€	10,798€	11,318€	11,838€	12,357€	12,878€	13,397€	13,917€	14,437€	14,957€	15,477€	54
<b>989</b>	10,407€	10,935€	11,463€	11,992€	12,520€	13,048€	13,576€	14,105€	14,633€	15,161€	15,689€	55
<b>1006</b>	10,536€	11,072€	11,608€	12,146€	12,682€	13,219€	13,756€	14,292€	14,829€	15,365€	15,903€	56

# CLIMATIC FORTE

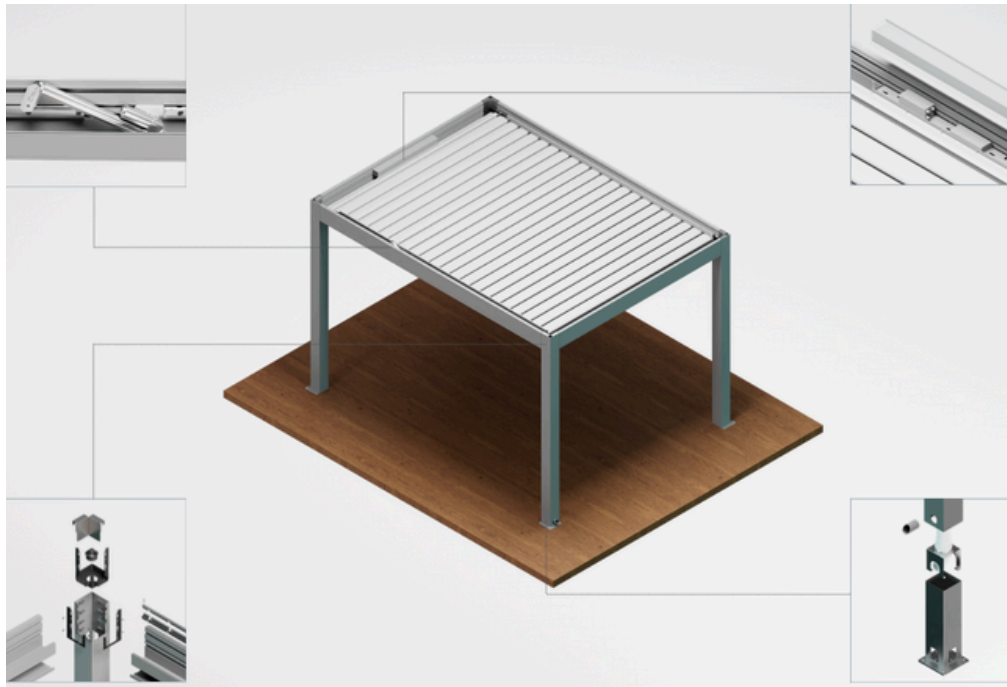

**Forte**  
Freistehend / 1 Motor  
Max Ausladung: 611 cm  
Max Breite: 450 cm  
Max Höhe: 300 cm

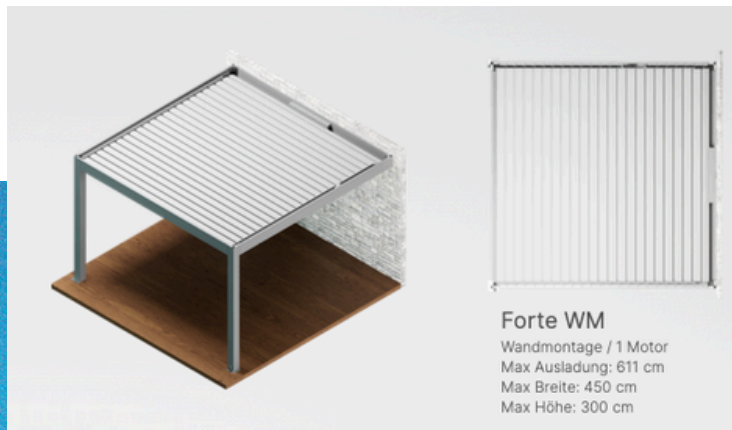

**Forte WM**  
Wandmontage / 1 Motor  
Max Ausladung: 611 cm  
Max Breite: 450 cm  
Max Höhe: 300 cm

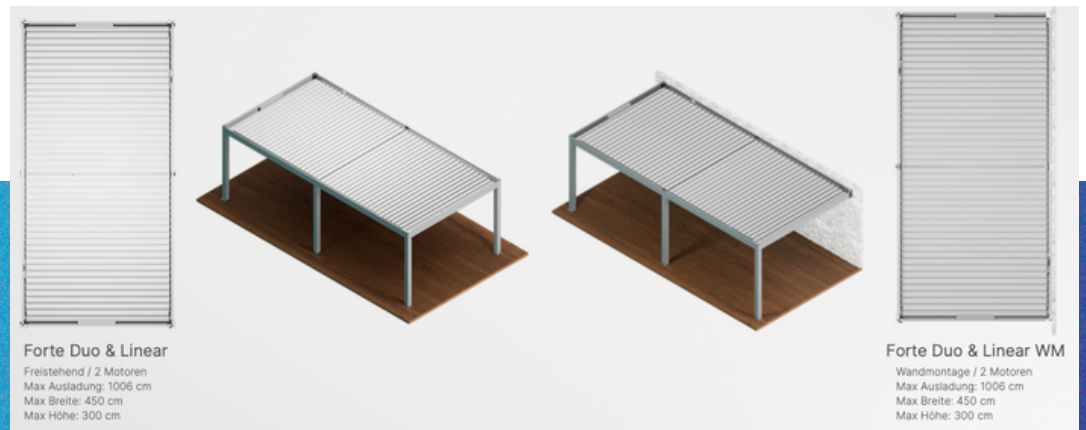

**Forte Duo & Linear**  
Freistehend / 2 Motoren  
Max Ausladung: 1006 cm  
Max Breite: 450 cm  
Max Höhe: 300 cm

**Forte Duo & Linear WM**  
Wandmontage / 2 Motoren  
Max Ausladung: 1006 cm  
Max Breite: 450 cm  
Max Höhe: 300 cm

# ECOCLIMATIC

## ELEKTRISCHE BEDIENING



**3x3 m**

**€ 3298,-**

**4x4 m**

**€ 5600,-**

**3x4 m**

**€ 3900,-**

**4x5 m**

**€ 6358,-**

**3x5 m**

**€ 4505,-**

**4x6 m**

**€ 7114,-**

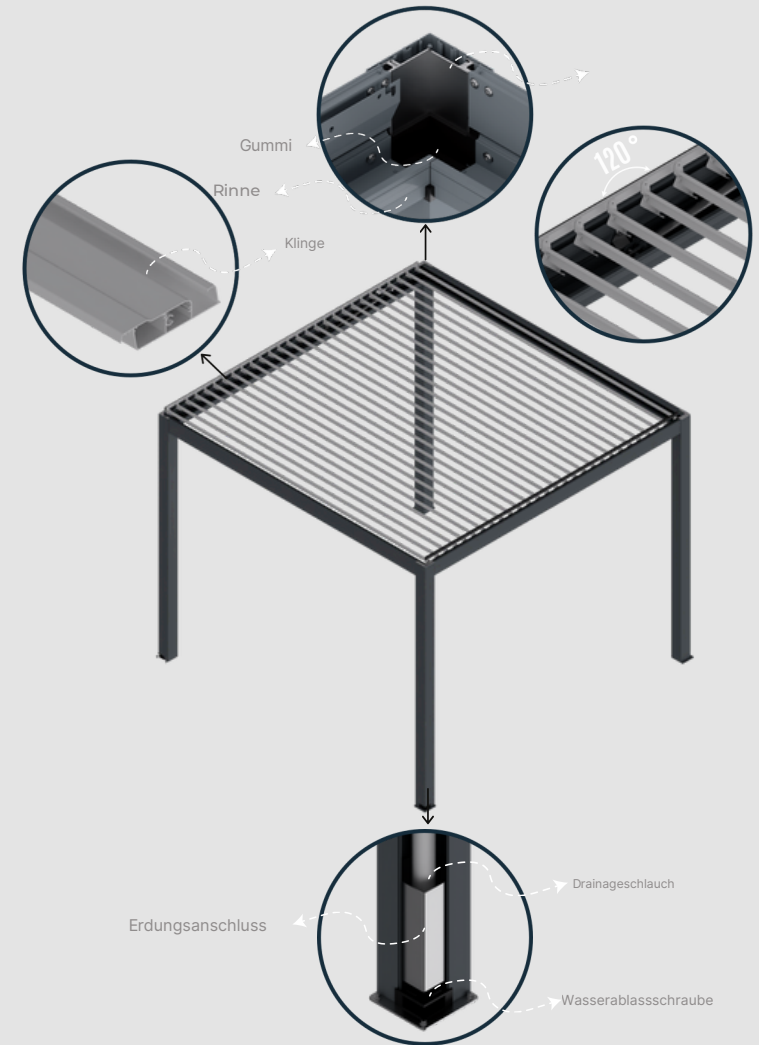

Premium Qualität



Lineares LED-Licht enthalten.



Weiß / Ral 9010



Anthrazit / Ral 7016



Anthrazit mit weißen Lamellen / Ral 7016 und Ral 9010



Fernbedienung



Einfache Montage



Schützt vor Sonne und Regen

# ECOCLIMATIC

## MANUELLE BEDIENUNG



**3x3 m**

**€ 2499,-**

Preis für LED-Licht : 260 €.

**3x5 m**

**€ 3485,-**

Preis für LED-Licht : 375 €.

**3x4 m**



**€ 2992,-**

Preis für LED-Licht : 305 €.



**4x6m**

**€ 5500,-**

Preis für LED-Licht : 520 €.

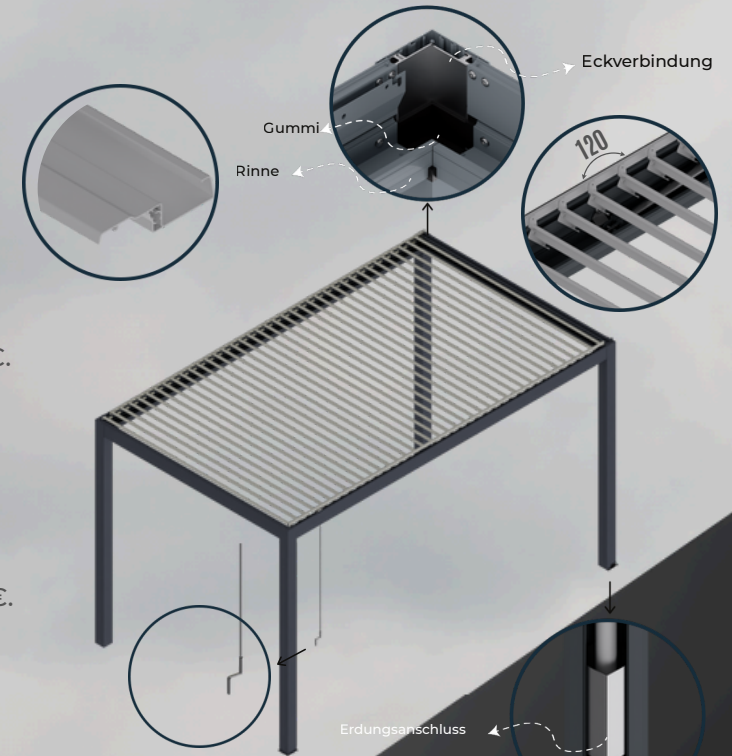
-  Weiß / Ral 9010
-  Anthrazit / Ral 7016
-  Anthrazit mit weißen Lamellen / RAL 7016 und RAL 9010



-  **Manuelle Steuerung**
-  **Schützt vor Sonne und Regen**
-  **Premium Qualität**
-  **Einfache Montage**

# MAXI PERGOLA



CM	250	300	350	400	450	500	550	600	650	700	750	800	850	900
300	2.688,64€	2.835,00€	2.981,36€	3.652,73€	3.773,64€	3.897,73€	4.034,55€	4.152,27€	4.280,18€	4.406,18€	5.218,18€	5.343,12€	5.466,36€	5.594,70€
350	2.780,91€	2.927,27€	3.073,64€	3.948,64€	4.072,73€	4.215,91€	4.365,45€	4.489,55€	4.630,82€	4.768,27€	5.638,18€	5.787,73€	5.934,09€	6.090,00€
400	2.975,00€	3.121,36€	3.267,73€	4.209,55€	4.343,18€	4.492,73€	4.626,36€	4.798,18€	4.932,14€	5.078,18€	6.070,91€	6.223,21€	6.379,55€	6.523,79€
450	3.150,00€	3.309,09€	3.468,18€	4.530,91€	4.690,00€	4.849,09€	5.011,36€	5.148,18€	5.312,68€	5.468,27€	6.495,15€	6.664,78€	6.839,85€	6.998,59€
500	3.334,55€	3.500,00€	3.665,45€	4.791,82€	4.957,27€	5.122,73€	5.316,82€	5.482,27€	5.656,32€	5.830,36€	6.921,52€	7.104,82€	7.296,44€	7.463,13€
550	3.484,09€	3.652,09€	3.820,09€	5.084,86€	5.262,73€	5.440,59€	5.634,05€	5.809,68€	5.992,67€	6.174,76€	7.347,88€	7.544,87€	7.753,03€	7.927,68€
600	3.650,18€	3.823,27€	3.996,36€	5.370,91€	5.561,18€	5.748,91€	5.955,09€	6.141,55€	6.336,08€	6.529,60€	7.774,24€	7.984,91€	8.209,62€	8.392,22€
650	3.816,27€	3.994,45€	4.172,64€	5.656,95€	5.859,64€	6.057,23€	6.276,14€	6.473,41€	6.679,50€	6.884,44€	8.200,61€	8.424,96€	8.666,21€	8.856,77€
700	3.982,36€	4.165,64€	4.348,91€	5.943,00€	6.158,09€	6.365,55€	6.597,18€	6.805,27€	7.022,91€	7.239,27€	8.626,97€	8.865,01€	9.122,80€	9.321,31€
750	4.148,45€	4.336,82€	4.525,18€	6.229,05€	6.456,55€	6.673,86€	6.918,23€	7.137,14€						
800	4.314,55€	4.508,00€	4.701,45€	6.515,09€	6.755,00€	6.982,18€	7.239,27€	7.469,00€						
850	4.480,64€	4.679,18€	4.877,73€	6.801,14€	7.053,45€	7.290,50€	7.560,32€	7.800,86€						
900	4.646,73€	4.850,36€	5.054,00€	7.087,18€	7.351,91€	7.598,82€	7.881,36€	8.132,73€						

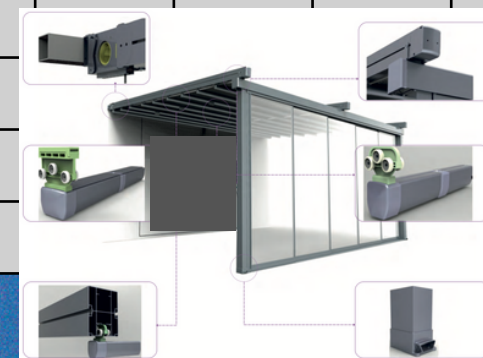

# FINE PERGOLA



CM	250	300	350	400	450	500	550	600	650	700	750	800	850	900	950	1000
<b>300</b>	2.314,57€	2.440,57€	2.566,57€	3.144,52€	3.248,61€	3.355,43€	3.473,22€	3.574,57€	3.697,83€	3.801,91€	4.492,17€	4.609,96€	4.705,83€	4.816,30€	4.923,13€	5.029,96€
<b>350</b>	2.394,00€	2.520,00€	2.646,00€	3.399,26€	3.506,09€	3.629,35€	3.758,09€	3.864,91€	3.990,91€	4.107,78€	4.853,74€	5.001,65€	5.108,48€	5.242,70€	5.370,07€	5.497,43€
<b>400</b>	2.561,09€	2.687,09€	2.813,09€	3.623,87€	3.738,91€	3.867,65€	3.982,70€	4.130,61€	4.382,61€	4.462,77€	5.226,26€	5.333,09€	5.491,96€	5.616,13€	5.748,98€	5.881,83€
<b>450</b>	2.711,74€	2.848,70€	2.985,65€	3.900,52€	4.037,48€	4.174,43€	4.314,13€	4.431,91€	4.708,57€	4.797,50€	5.591,48€	5.704,70€	5.888,22€	6.024,87€	6.173,24€	6.321,61€
<b>500</b>	2.870,61€	3.013,04€	3.155,48€	4.125,13€	4.267,57€	4.410,00€	4.577,09€	4.719,52€	5.050,96€	5.140,25€	5.958,52€	6.066,26€	6.281,28€	6.424,78€	6.586,16€	6.747,54€
<b>550</b>	2.999,35€	3.143,97€	3.288,60€	4.377,40€	4.530,52€	4.683,64€	4.850,18€	5.001,38€	5.393,35€	5.471,96€	6.325,57€	6.427,83€	6.674,35€	6.824,70€	6.999,09€	7.173,48€

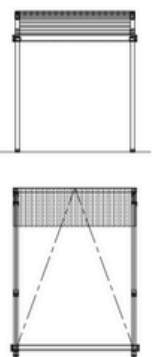

1 MODULE

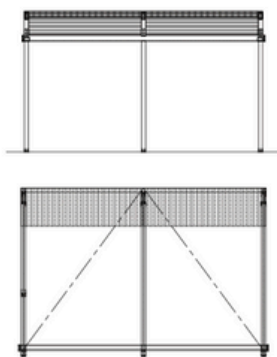

2 MODULES

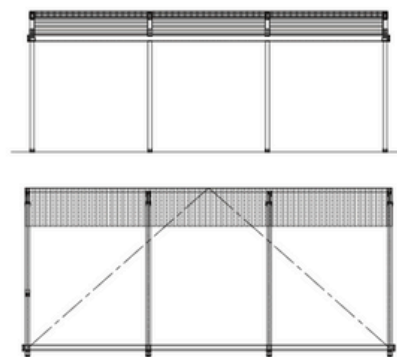

3 MODULES

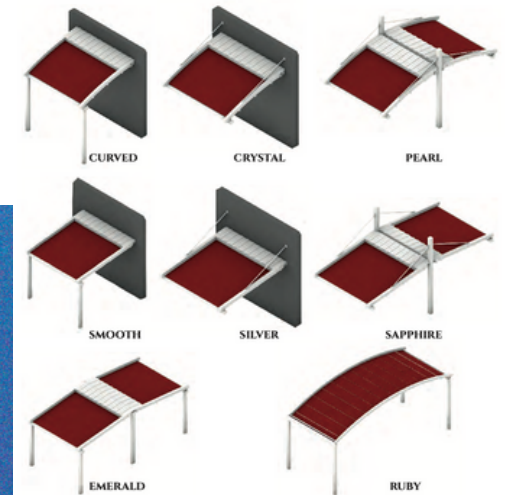
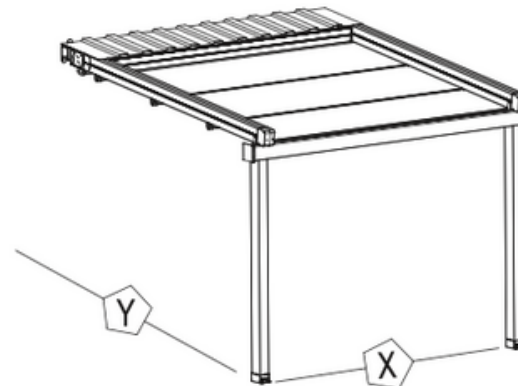

# GIOTIN SYSTEME

Panorama_8mm_esg											
CM	200	225	250	275	300	325	350	375	400	425	450
200	1.488€	1.534€	1.580€	1.625€	1.671€	1.717€	1.763€	1.808€	1.854€	1.899€	1.945€
225	1.546€	1.594€	1.643€	1.692€	1.741€	1.790€	1.839€	1.887€	1.936€	1.985€	2.034€
250	1.602€	1.654€	1.706€	1.758€	1.811€	1.863€	1.915€	1.967€	2.019€	2.072€	2.124€
275	1.658€	1.714€	1.769€	1.825€	1.880€	1.936€	1.991€	2.047€	2.102€	2.158€	
300	1.715€	1.773€	1.831€	1.892€	1.950€	2.009€	2.067€	2.126€	2.185€		
325	1.772€	1.833€	1.894€	1.958€	2.019€	2.082€	2.144€	2.206€			
350	1.828€	1.893€	1.957€	2.025€	2.089€	2.154€	2.220€				
ISO Glas Panorama_21mm_esg											
CM	200	225	250	275	300	325	350	375	400	425	450
200	1.623€	1.692€	1.762€	1.832€	1.901€	1.971€	2.041€	2.110€	2.180€	2.249€	2.319€
225	1.690€	1.765€	1.839€	1.914€	1.988€	2.063€	2.138€	2.212€	2.287€	2.361€	2.436€
250	1.756€	1.837€	1.916€	1.997€	2.077€	2.158€	2.238€	2.318€	2.399€	2.479€	2.559€
275	1.823€	1.909€	1.995€	2.080€	2.165€	2.251€	2.336€	2.422€			
300	1.889€	1.981€	2.072€	2.162€	2.254€	2.345€	2.436€				
325	1.956€	2.053€	2.149€	2.245€	2.341€	2.438€					
350	2.023€	2.125€	2.226€	2.328€							





**EG ALUMINIUM GMBH**

Neuenacker 5  
69253 Heiligkreuzsteinach

+6220 9157787  
info@eg-aluminium.de  
www.eg-aluminium.de



**EG VERANDA GMBH**

Gersteinstr. 8  
59227 Ahlen

T+2382 8880 100  
info@egveranda.de  
www.egveranda.de